

9. Factor of safety and probability of failure

Introduction

How does one assess the acceptability of an engineering design? Relying on judgement alone can lead to one of the two extremes illustrated in Figure 1. The first case is economically unacceptable while the example illustrated in the drawing on the right violates all normal safety standards.

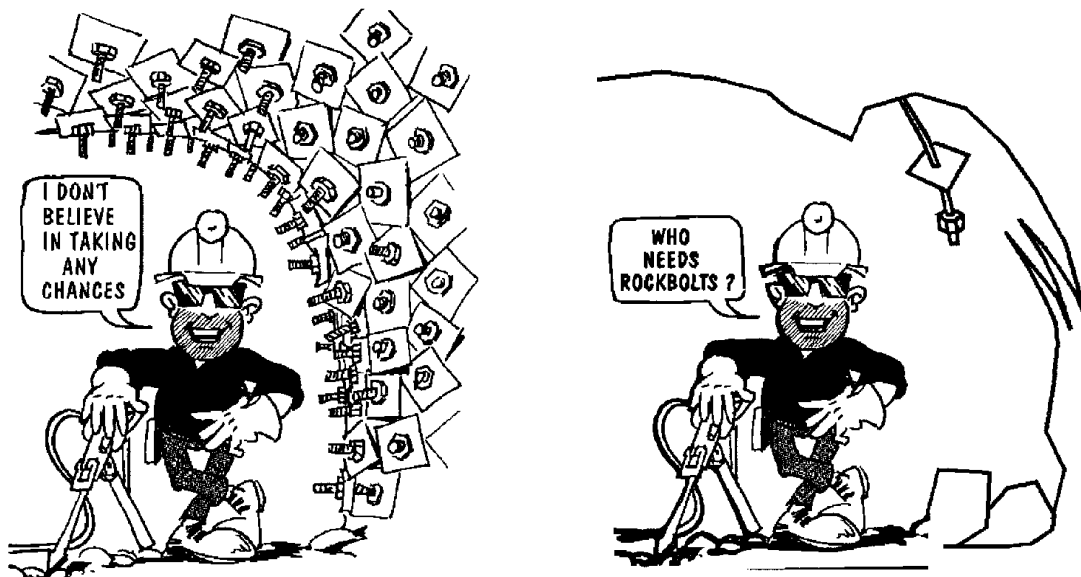

Figure 1: Rock bolting alternatives involving individual judgement. (Drawings from a brochure on rockfalls published by the Department of Mines of Western Australia.)

Sensitivity studies

The classical approach used in designing engineering structures is to consider the relationship between the capacity C (strength or resisting force) of the element and the demand D (stress or disturbing force). The Factor of Safety of the structure is defined as $F = C/D$. Failure is assumed to occur when F is less than unity.

Rather than base an engineering design decision on a single calculated factor of safety, an approach which is frequently used to give a more rational assessment of the risks associated with a particular design, is to carry out a sensitivity study. This involves a series of calculations in which each significant parameter is varied systematically over its maximum credible range to determine its influence upon the factor of safety. This is a useful means of exploring a range of possibilities and reaching practical decisions on some difficult problems. On the following pages this idea of sensitivity studies will be extended to the use of probability theory, and it will be shown that, even with very limited field data, useful information can be obtained from an analysis of probability of failure.

An introduction to probability theory

A complete discussion on probability theory exceeds the scope of these notes. The techniques discussed on the following pages are intended to introduce the reader to the subject and to give an indication of the power of these techniques in engineering decision making. A more detailed treatment of this subject will be found in a book by Harr (1987) entitled, 'Reliability-based design in civil engineering'. A paper on geotechnical applications of probability theory entitled 'Evaluating calculated risk in geotechnical engineering', was published by Whitman (1984). It is recommended reading for anyone with a serious interest in this subject. Pine (1992), Tyler et al (1991), Hatzor and Goodman (1993) and Carter (1992) have published papers on the application of probability theory to the analysis of problems encountered in underground mining and civil engineering.

Many geotechnical engineers regard the subject of probability theory with doubt and suspicion. At least part of the reason for this mistrust is associated with the language which has been adopted by those who specialise in the field of probability theory and risk assessment. The following definitions are given to dispel some of the mystery which tends to surround this subject.

Random variables: Parameters such as the angle of friction of rock joints, the uniaxial compressive strength of rock specimens, the inclination and orientation of discontinuities in a rock mass and the measured in situ stresses in the rock surrounding an opening do not have a single fixed value but may several values. There is no way of predicting exactly what the value of one of these parameters will be at any given location. Hence, these parameters are described as random variables.

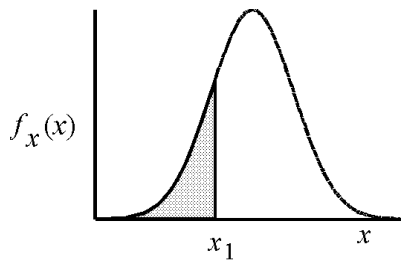

Probability density function (PDF)

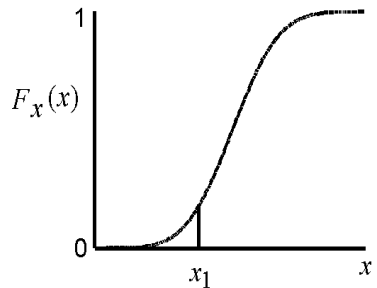

Cumulative distribution function (CDF)

Probability distribution: A probability density function (PDF) describes the relative likelihood that a random variable will assume a particular value. A typical probability density function is illustrated opposite. In this case the random variable is continuously distributed (i.e., it can take on all possible values). The area under the PDF is always unity.

An alternative way of presenting the same information is in the form of a cumulative distribution function (CDF), which gives the probability that the variable will have a value less than or equal to the selected value. The CDF is the integral of the corresponding probability density function, i.e., the ordinate at x_1 on the cumulative distribution is the area under the probability density function to the left of x_1 . Note the $f_x(x)$ is used for the ordinate of a PDF while $F_x(x)$ is used for a CDF.

One of the most common graphical representations of a probability distribution is a histogram in which the fraction of all observations falling within a specified interval is plotted as a bar above that interval.

Data analysis: For many applications it is not necessary to use all the information contained in a distribution function and quantities summarised only by the dominant features of the distribution may be adequate.

The sample mean or expected value or first moment indicates the centre of gravity of a probability distribution. A typical application would be the analysis of a set of results x_1, x_2, \dots, x_n from uniaxial strength tests carried out in the laboratory. Assuming that there are n individual test values x_i , the mean \bar{x} is given by:

$$\bar{x} = \frac{1}{n} \sum_{i=1}^n x_i \quad (1)$$

The sample variance s^2 or the second moment of the mean of a distribution is defined as the mean of the square of the difference between the value of x_i and the mean value \bar{x} .

Hence:

$$s^2 = \frac{1}{n-1} \sum_{i=1}^n (x_i - \bar{x})^2 \quad (2)$$

Note that, theoretically, the denominator for calculation of variance of samples should be n , not $(n - 1)$. However, for a finite number of samples, it can be shown that the correction factor $n/(n-1)$, known as Bessel's correction, gives a better estimate. For practical purposes the correction is only necessary when the sample size is less than 30.

The *standard deviation* s is given by the positive square root of the variance s^2 . In the case of the commonly used normal distribution, about 68% of the test values will fall within an interval defined by the *mean \pm one standard deviation* while approximately 95% of all the test results will fall within the range defined by the *mean \pm two standard deviations*. A small standard deviation will indicate a tightly clustered data set while a large standard deviation will be found for a data set in which there is a large scatter about the mean.

The *coefficient of variation* (COV) is the ratio of the standard deviation to the mean, i.e., $COV = s/\bar{x}$. COV is dimensionless and it is a particularly useful measure of uncertainty. A small uncertainty would typically be represented by a $COV = 0.05$ while considerable uncertainty would be indicated by a $COV = 0.25$.

Normal distribution: The *normal* or *Gaussian* distribution is the most common type of probability distribution function, and the distributions of many random variables conform to this distribution. It is generally used for probabilistic studies in geotechnical engineering unless there are good reasons for selecting a different distribution. Typically, variables which arise as a sum of several random effects, none of which dominate the total, are normally distributed.

The problem of defining a normal distribution is to estimate the values of the governing parameters which are the true mean (μ) and true standard deviation (σ). Generally, the best estimates for these values are given by the sample mean and standard deviation, determined from several tests or observations. Hence, from equations 1 and 2:

$$\mu = \bar{x} \quad (3)$$

$$\sigma = s \quad (4)$$

It is important to recognise that equations 3 and 4 give the most probable values of μ and σ and not necessarily the true values.

Obviously, it is desirable to include as many samples as possible in any set of observations but, in geotechnical engineering, there are serious practical and financial limitations to the amount of data which can be collected. Consequently, it is often necessary to make estimates based on judgement, experience or from comparisons with results published by others. These difficulties are often used as an excuse for not using probabilistic tools in geotechnical engineering, but as will be shown later in this chapter, useful results can still be obtained from very limited data.

Having estimated the mean μ and standard deviation σ , the probability density function for a normal distribution is defined by:

$$f_x(x) = \frac{\exp\left[-\frac{1}{2}\left(\frac{x-\mu}{\sigma}\right)^2\right]}{\sigma\sqrt{2\pi}} \quad (5)$$

for $-\infty \leq x \leq \infty$.

As will be seen later, this range of $-\infty \leq x \leq \infty$ can cause problems when a normal distribution is used as a basis for a Monte Carlo analysis in which the entire range of values is randomly sampled. This can give rise to a few very small numbers (sometimes negative) and very large numbers which, in certain analyses, can cause numerical instability. To overcome this problem, the normal distribution is sometimes truncated so that only values falling within a specified range are considered valid.

There is no closed form solution for the cumulative distribution function (CDF) which must be found by numerical integration.

Other distributions: In addition to the commonly used normal distribution there are several alternative distributions which are used in probability analyses. Some of the most useful are:

Beta distributions (Harr, 1987) are very versatile distributions which can be used to replace almost any of the common distributions, and which do not suffer from the extreme value problems discussed above because the domain (range) is bounded by specified values.

Exponential distributions are sometimes used to define events such as the occurrence of earthquakes or rockbursts or quantities such as the length of joints in a rock mass.

Lognormal distributions are useful when considering processes such as the crushing of aggregates in which the final particle size results from several collisions of particles of many sizes moving in different directions with different velocities. Such multiplicative

mechanisms tend to result in variables which are lognormally distributed as opposed to the normally distributed variables resulting from additive mechanisms.

Weibul distributions are used to represent the lifetime of devices in reliability studies or the outcome of tests such as point load tests on rock core in which a few very high values may occur.

It is no longer necessary for the person starting out in the field of probability theory to know and understand the mathematics involved in all these probability distributions since commercially available software programs can be used to carry out many of the computations automatically. Note that the author is not advocating the blind use of ‘black-box’ software and the reader should exercise extreme caution is using such software without trying to understand what the software is doing. However, there is no point in writing reports by hand if one is prepared to spend the time learning how to use a good word-processor correctly and the same applies to mathematical software.

One of the most useful software packages for probability analysis is a Microsoft Excel add-in program called @RISK¹ which can be used for risk evaluations using the techniques described below.

Sampling techniques: Consider a problem in which the factor of safety depends upon several random variables such as the cohesive strength c , the angle of friction ϕ and the acceleration α due to earthquakes or large blasts. Assuming that the values of these variables are distributed about their means in a manner which can be described by one of the continuous distribution functions such as the normal distribution described earlier, the problem is how to use this information to determine the distribution of factor of safety values and the probability of failure.

The Monte Carlo method uses random or pseudo-random numbers to sample from probability distributions and, if sufficiently large numbers of samples are generated and used in a calculation such as that for a factor of safety, a distribution of values for the product will be generated. The term ‘Monte Carlo’ is believed to have been introduced as a code word to describe this hit-and-miss technique used during secret work on the development of the atomic bomb during World War II (Harr 1987). Today, Monte Carlo techniques can be applied to a wide variety of problems involving random behaviour and several algorithms are available for generating random Monte Carlo samples from different types of input probability distributions. With highly optimised software programs such as @RISK, problems involving relatively large samples can be run efficiently on most desktop or portable computers.

¹ @RISK is available from www.palisade.com.

The *Latin Hypercube* sampling technique (Imam et al, 1980, Startzman and Watterbarger, 1985) is a relatively recent development which gives comparable results to the Monte Carlo technique but with fewer samples. The method is based upon stratified sampling with random selection within each stratum. Typically, an analysis using 1000 samples obtained by the Latin Hypercube technique will produce comparable results to an analysis using 5000 samples obtained using the Monte Carlo method. Both techniques are incorporated in the program @RISK.

Note that both the Monte Carlo and the Latin Hypercube techniques require that the distribution of all the input variables should either be known or that they be assumed. When no information on the distribution is available it is usual to assume a normal or a truncated normal distribution.

The *Generalised Point Estimate Method*, developed by Rosenbleuth (1981) and discussed in detail by Harr (1987), can be used for rapid calculation of the mean and standard deviation of a quantity such as a factor of safety which depends upon random behaviour of input variables. Hoek (1989) discussed the application of this technique to the analysis of surface crown pillar stability while Pine (1992) has applied this technique to the analysis of slope stability and other mining problems.

To calculate a quantity such as a factor of safety, two-point estimates are made at one standard deviation on either side of the mean ($\mu \pm \sigma$) from each distribution representing a random variable. The factor of safety is calculated for every possible combination of point estimates, producing 2^n solutions where n is the number of random variables involved. The mean and the standard deviation of the factor of safety are then calculated from these 2^n solutions.

While this technique does not provide a full distribution of the output variable, as do the Monte Carlo and Latin Hypercube methods, it is very simple to use for problems with relatively few random variables and is useful when general trends are being investigated. When the probability distribution function for the output variable is known, for example, from previous Monte Carlo analyses, the mean and standard deviation values can be used to calculate the complete output distribution.

Some of the techniques described above have been incorporated into specialized commercial software packages and one of these called RocPlane² was used to analyse the Sau Mau Ping slope.

² Available from www.rocscience.com

Probability of failure

In the case of a rock slope problem, illustrated below, the input parameters and assumed distributions for the calculation of the factor of safety of the overall slope with a tension crack are as follows:

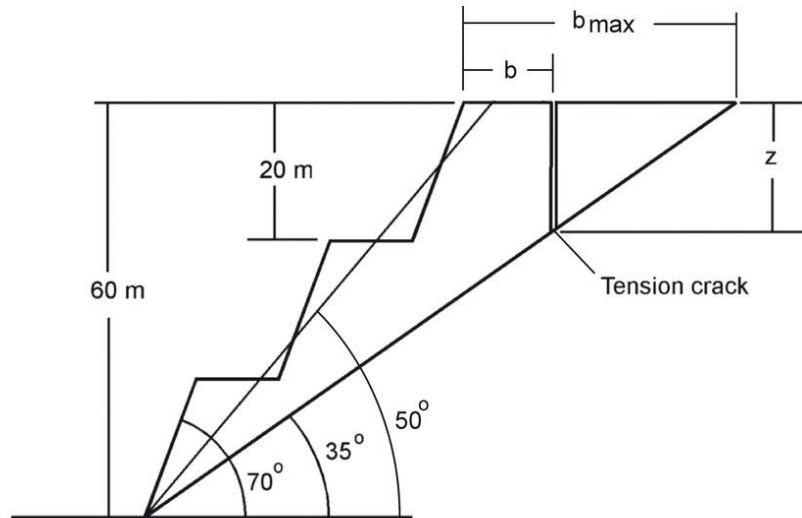

1. Fixed dimensions:

Overall slope height	$H = 60 \text{ m}$
Overall slope angle	$\psi_f = 50^\circ$
Failure plane angle	$\psi_p = 35^\circ$
Upper slope inclination	horizontal
Bench width $b_{\max} = H(\cot \psi_p - \cot \psi_f)$	$b_{\max} = 35.34 \text{ m}$
Unit weight of rock	$\gamma_r = 2.6 \text{ tonnes/m}^3$
Unit weight of water	$\gamma_w = 1.0 \text{ tonnes/m}^3$

2. Random variables

	<i>Mean values</i>	<i>Standard deviation</i>	<i>Distribution</i>
Friction angle on joint surface	$\phi = 35^\circ$	± 5	Normal
Cohesive strength of joint surface	$c = 10 \text{ tonnes/m}^2$	± 2	Normal
Depth of tension crack	$z = 14 \text{ m}$	± 3	Normal
Distance from crest to tension crack	$b = 15.3 \text{ m}$	± 4	Normal
Depth of water in tension crack	$z_w = z/2$ min = 0, max = z		Exponential
Ratio of horizontal earthquake to gravitational acceleration	$\alpha = 0.08$ min = 0, max = 2α		Exponential

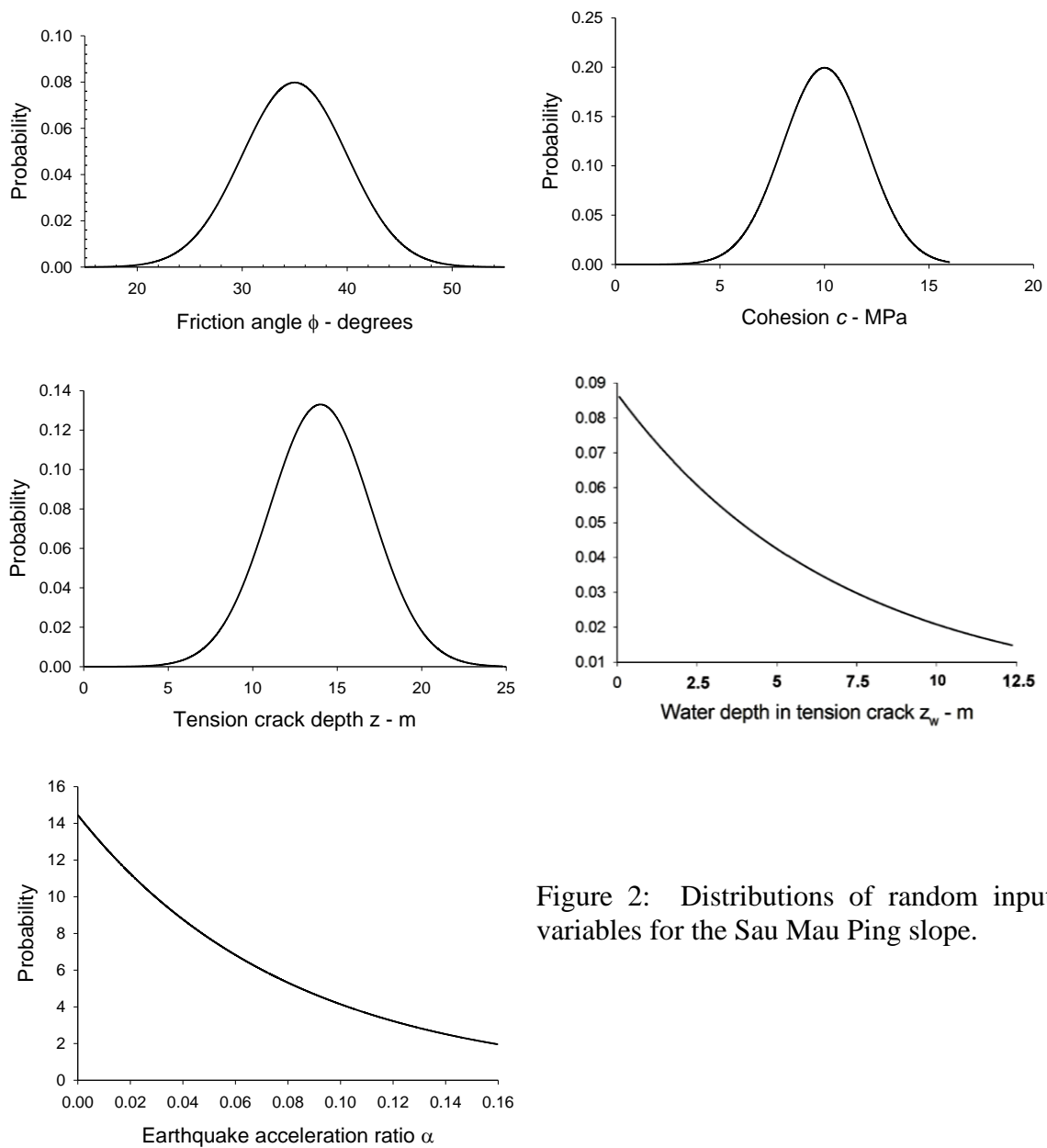

Figure 2: Distributions of random input variables for the Sau Mau Ping slope.

Figure 2 illustrates the plots of the probability distribution functions of the random input variables. It is worth discussing each of the plots in detail to demonstrate the reasoning behind the choice of the probability distribution functions.

Friction angle ϕ - A truncated normal distribution has been assumed for this variable. The mean is assumed to be 35° which is typical for the relatively rough surfaces of discontinuities in rock masses. The standard deviation of 5° implies that about 68% of the friction angle values defined by the distribution will lie between 30° and 40° . The normal distribution is truncated by a minimum value of 15° and a maximum value of 70° which have been arbitrarily chosen as the extreme values represented by a smooth slickensided surface and a fresh, rough tension fracture.

Cohesive strength c - Again using a typical range of shear strength values, a value of 10 tonnes/m² has been chosen as the mean cohesive strength and the standard deviation has been set at 2 tonnes/m². To allow for the wide range of possible cohesive strengths the minimum and maximum values used to truncate the normal distribution are 0 and 25 tonnes/m² respectively. Those with experience in the interpretation of laboratory shear strength test results may argue that the friction angle ϕ and the cohesive strength c are not independent variables as has been assumed in this analysis. This is because the cohesive strength generally drops as the friction angle rises and vice versa. The program @RISK allows the user to define variables as dependent but, for the sake of simplicity, the friction angle ϕ and the cohesive strength c have been kept independent for this analysis.

Distance of tension crack behind face b - The RocScience program, RocPlane, uses the horizontal distance b of the tension crack behind the slope crest as input in place of the tension crack depth z because b can be measured in the field and because it is not influenced by the inclination of the upper slope. Hoek and Bray (1974) give the value of b as $b = H(\sqrt{\cot\psi_f \tan\psi_p} - \cot\psi_f)$ with the limits as $0 < b < H(\cot\psi_p - \cot\psi_f)$.

Tension crack depth z - The tension crack depth z has a value of 14 m for the assumed conditions shown for this slope. A truncated normal distribution is assumed to define the possible range of tension crack depths and the standard deviation has been arbitrarily chosen at 3 m. The minimum tension crack depth is zero, but a value of 0.1 m has been chosen to avoid possible numerical problems. The maximum tension crack depth is given by $z = H(1 - \tan\psi_p / \tan\psi_f) = 24.75$ m which occurs when the vertical tension crack is located at the crest of the slope.

Water depth z_w in tension crack - The water which would fill the tension crack in this slope would come from direct surface run-off during heavy rains. In Hong Kong the heaviest rains occur during typhoons and it is likely that the tension crack would be filled completely during such events. The probability of occurrence of typhoons has been

defined by a truncated exponential distribution where the mean water depth is assumed to be one half of the tension crack depth. The maximum water depth cannot exceed the tension crack depth z and, as defined by the exponential distribution, this value would occur very rarely. The minimum water depth is zero during dry conditions which is assumed to be a frequent occurrence.

Ratio of horizontal earthquake acceleration to gravitational acceleration α - The frequent occurrence of earthquakes of different magnitudes can be estimated by means of an exponential distribution which suggests that large earthquakes are very rare while small ones are very common. In this case, a 'design' horizontal acceleration of 0.08g has been assumed. In other words, this level of acceleration could be anticipated at least once during the operating life of a civil engineering structure. A rough rule of thumb suggests that the 'maximum credible' acceleration is approximately twice the 'design' value. Based upon these very crude guidelines, the distribution of values of α used in these calculations was defined by a truncated exponential distribution with a mean value of $\alpha = 0.08$, a maximum of 0.16 and a minimum of 0.

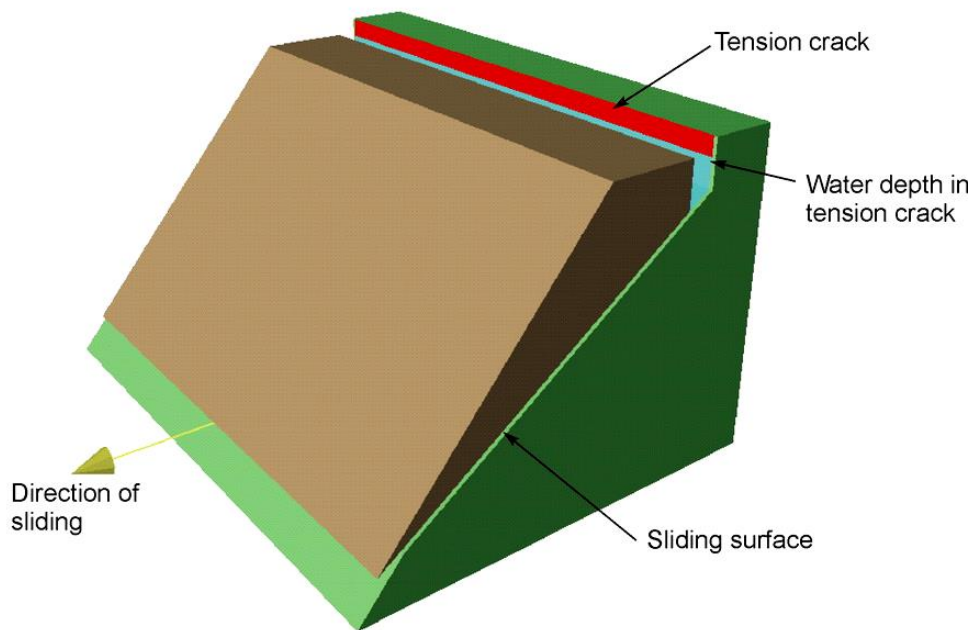

Figure 3: RocPlane model of the defined slope.

Using the distributions shown in Figure 2, the RocPlane model shown in Figure 3 was used, with Latin Hypercube sampling, to carry out 5,000 iterations on the factor of safety. The resulting probability distribution is plotted in Figure 4. This histogram gives a mean

factor of safety of 1.34 with a standard deviation of 0.23, a minimum of 0.61 and a maximum of 2.33. The best fit distribution is a beta distribution with the same mean, standard deviation, minimum and maximum.

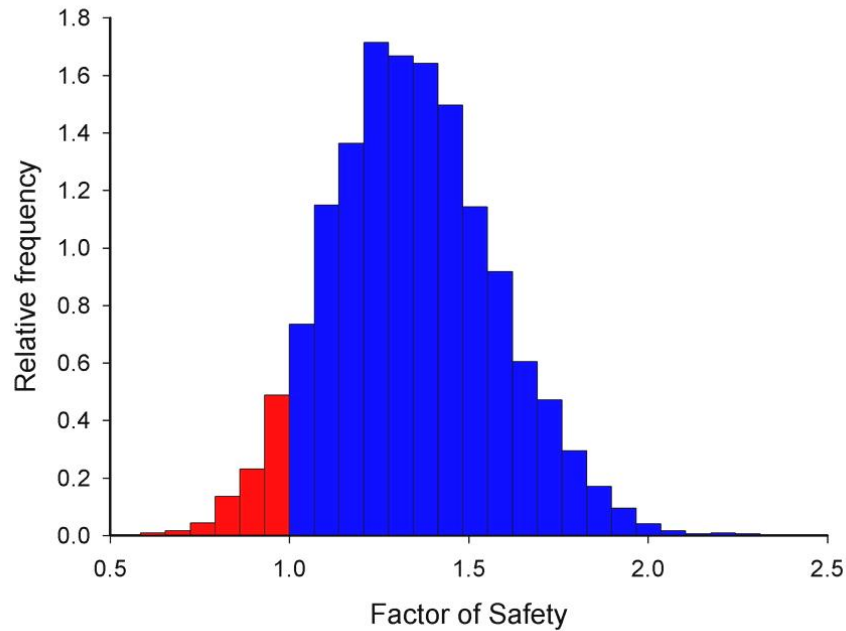

Figure 4: Distribution of the factor of safety for the rock slope computed by means of the program RocPlane.

The calculated *probability of failure* is found to be 6.4% and is given by the ratio of the area under the distribution curve for $F < 1$ (shown in red in Figure 4) divided by the total area under the distribution curve. This means that, for the combination of slope geometry, shear strength, water pressure and earthquake acceleration parameters assumed, 64 out of 1000 similar slopes could be expected to fail at some time during the life of the slope. Alternatively, a length of 64 m could be expected to fail in every 1000 m of slope.

This is a reasonable risk of failure for short term conditions and a risk of this magnitude may be acceptable in an open pit mine, with limited access for trained miners, and even on a rural road. However, in the long term, this probability of failure is not acceptable for a densely populated region. In considering remedial measures to improve the long-term stability of the slope, the effectiveness of these measures could be evaluated using the same probabilistic techniques as described above.

Acknowledgements

The author wishes to express his thanks to Dr. Eugenio Casteli, Mr. Damiano Giordano and Dr. Bak Kong Low for bringing to his attention several errors in the original Monte Carlo analysis. These errors have been corrected in this revision on the notes.

References

- Carter, T.G. 1992. A new approach to surface crown pillar design. *Proc. 16th. Canadian Rock Mechanics Symp., Sudbury*, 75-83.
- Carter, T.G. 1992. Prediction and uncertainties in geological engineering and rock mass characterization assessments. *Proc. 4th. int. rock mechanics and rock engineering conf., Torino*. Paper 1.
- Harr, M.E. 1987. *Reliability-based design in civil engineering*. New York: McGraw-Hill.
- Hatzor, Y. and Goodman. R.E. 1993. Determination of the 'design block' for tunnel supports in highly jointed rock. In *Comprehensive Rock Engineering, Principles, Practice and Projects*. (ed. J.A. Houson) **2**, 263-292. Oxford: Pergamon.
- Hoek, E. and Bray, J.W. 1974. *Rock Slope Engineering*. London: Instn Min. Metall.
- Hoek, E. 1989. A limit equilibrium analysis of surface crown pillar stability. In *Surface crown pillar evaluation for active and abandoned metal mines*, (ed. M.C. Betourney), 3-13. Ottawa: Dept. Energy, Mines & Resources Canada.
- Iman, R.L., Davenport, J.M. and Zeigler, D.K. 1980. *Latin Hypercube sampling (A program user's guide)*. Technical Report SAND79-1473. Albuquerque, New Mexico: Sandia Laboratories.
- Pine, R.J. 1992. Risk analysis design applications in mining geomechanics. *Trans. Instn Min. Metall.* (Sect.A) **101**, 149-158.
- Rosenbleuth, E. 1981. Two-point estimates in probabilities. *J. Appl. Math. Modelling* **5**, October, 329-335.
- Startzman, R.A. and Wattenbarger, R.A. 1985. An improved computation procedure for risk analysis problems with unusual probability functions. *Proc. symp. Soc. Petrolm Engrs hydrocarbon economics and evaluation*, Dallas.
- Tyler, D.B., Trueman, R.T. and Pine, R.J. 1991. Rockbolt support design using a probabilistic method of key block analysis. In *Rock mechanics as a multidisciplinary science*, (ed. J.C. Roegiers), 1037-1047. Rotterdam: Balkema.
- Whitman. R.V. 1984. Evaluating calculated risk in geotechnical engineering. *J. Geotech. Engng, ASCE* **110** (2), 145-186.